

Схема скважин
E6101.0000.0000

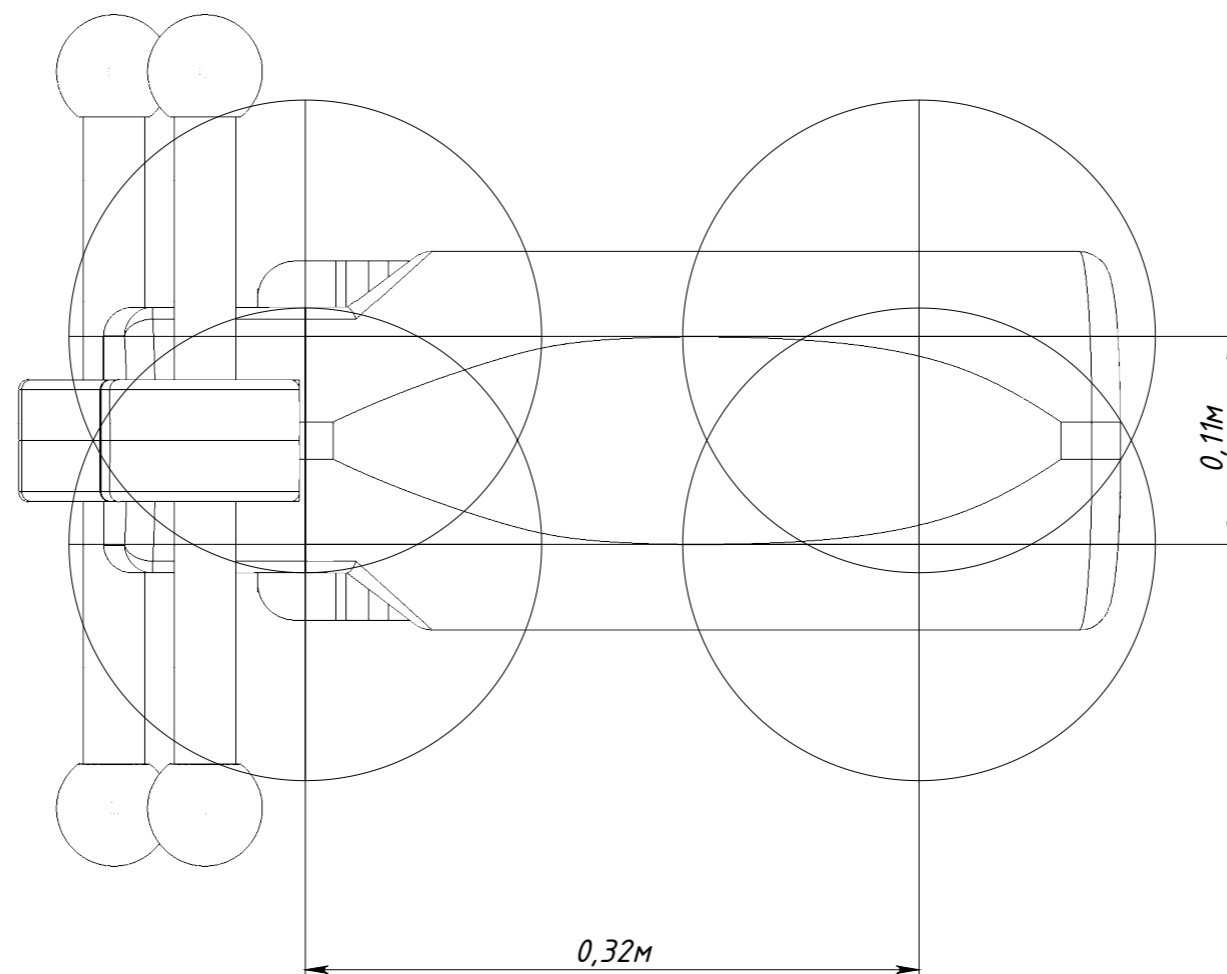

Рисунок 1