

Схема скважин  
E5304.0000.0000

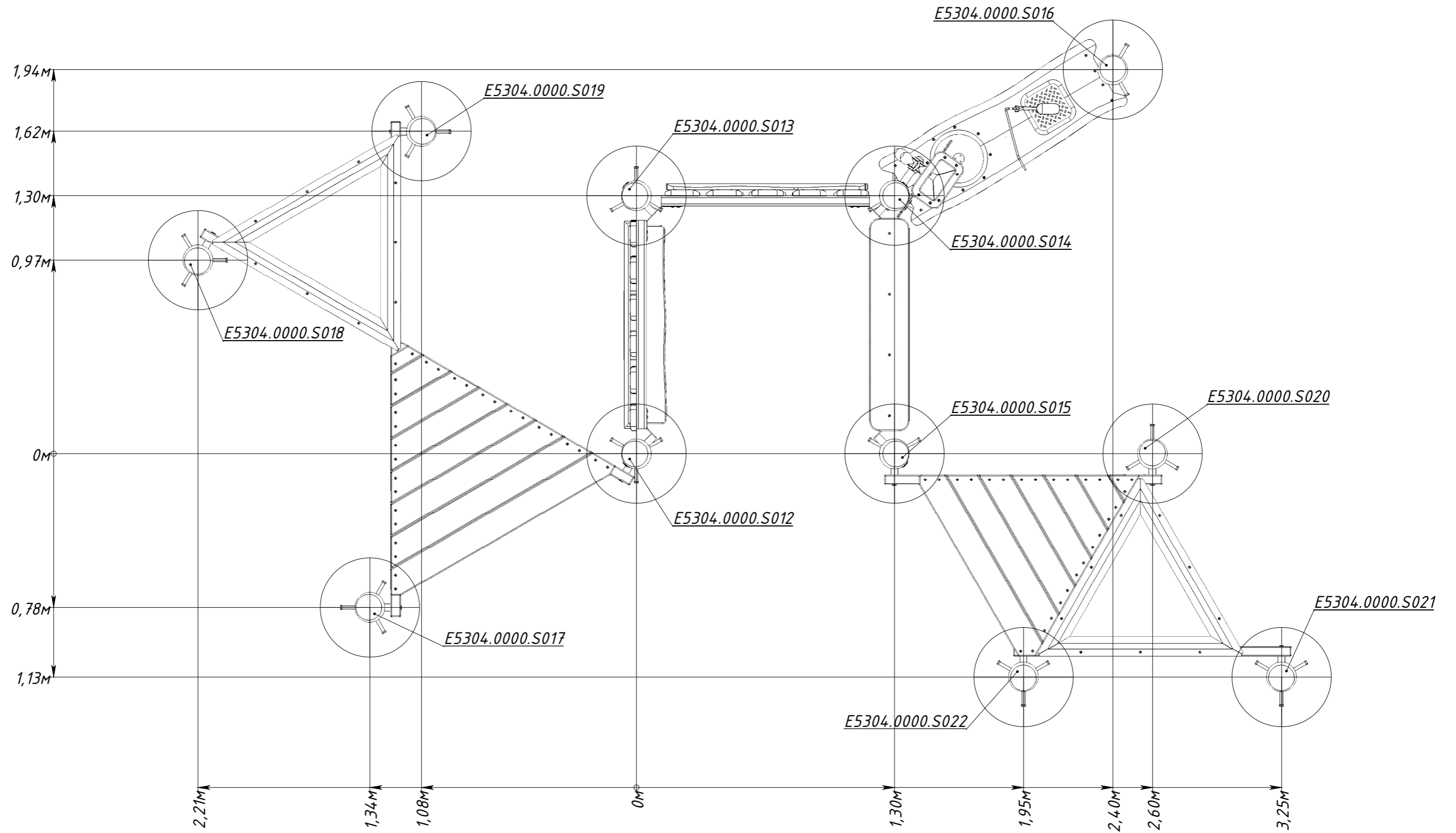

Рисунок 1