

Схема скважин  
E1203.0000.0000

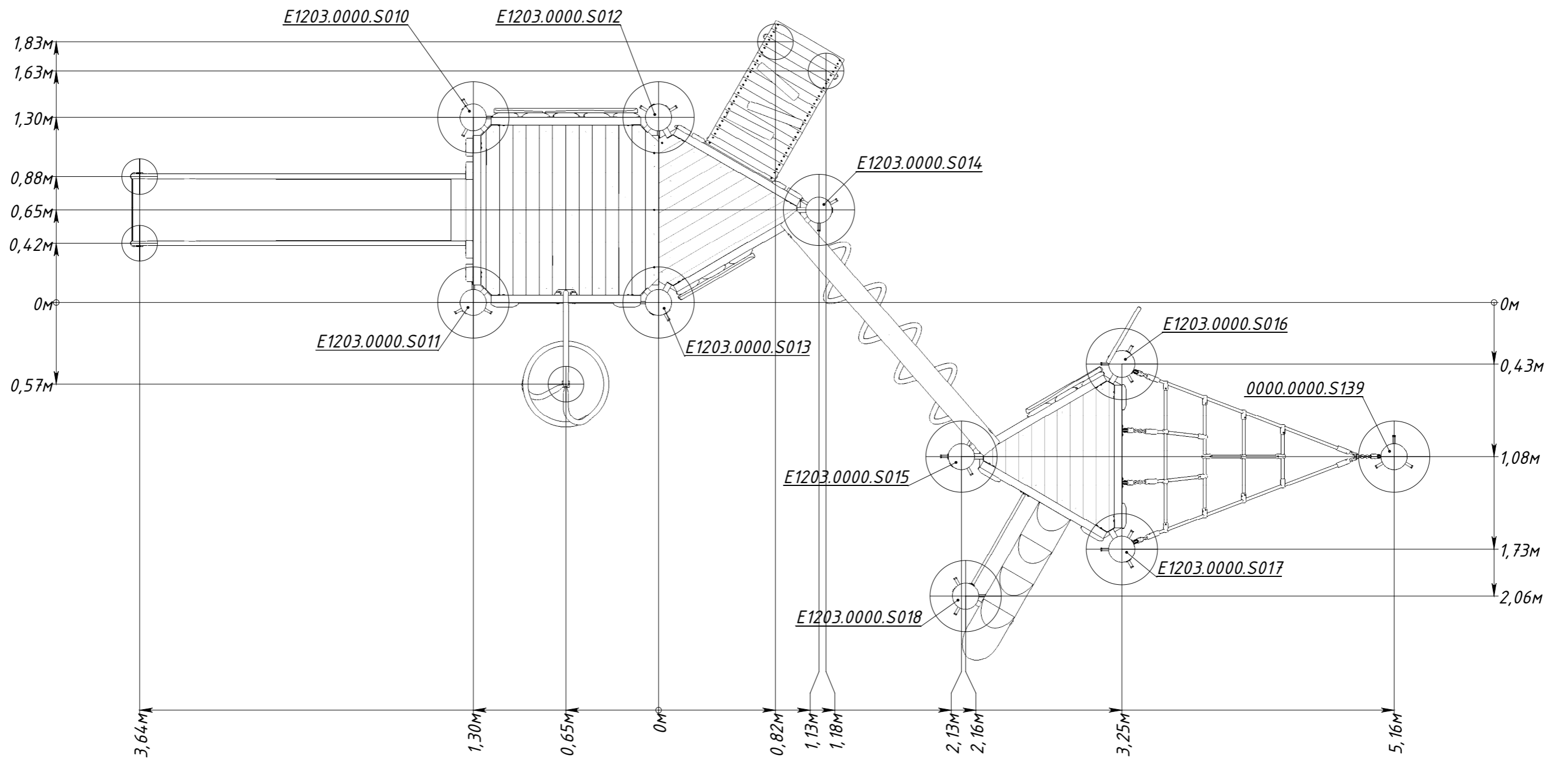

Рисунок 1