

Схема скважин
4436.0000.0000

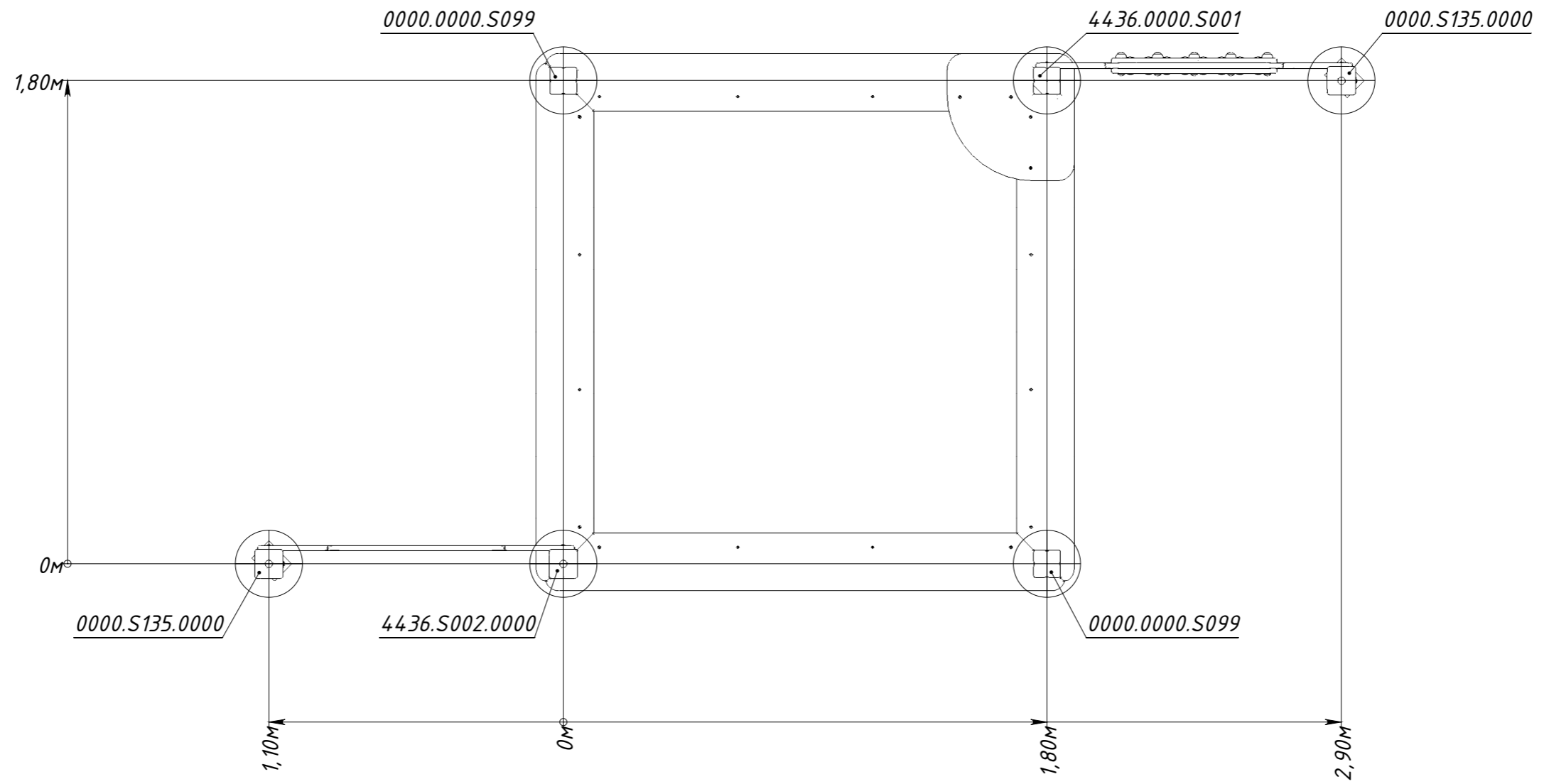

Рисунок 1