

Схема скважин  
4426.0000.0000

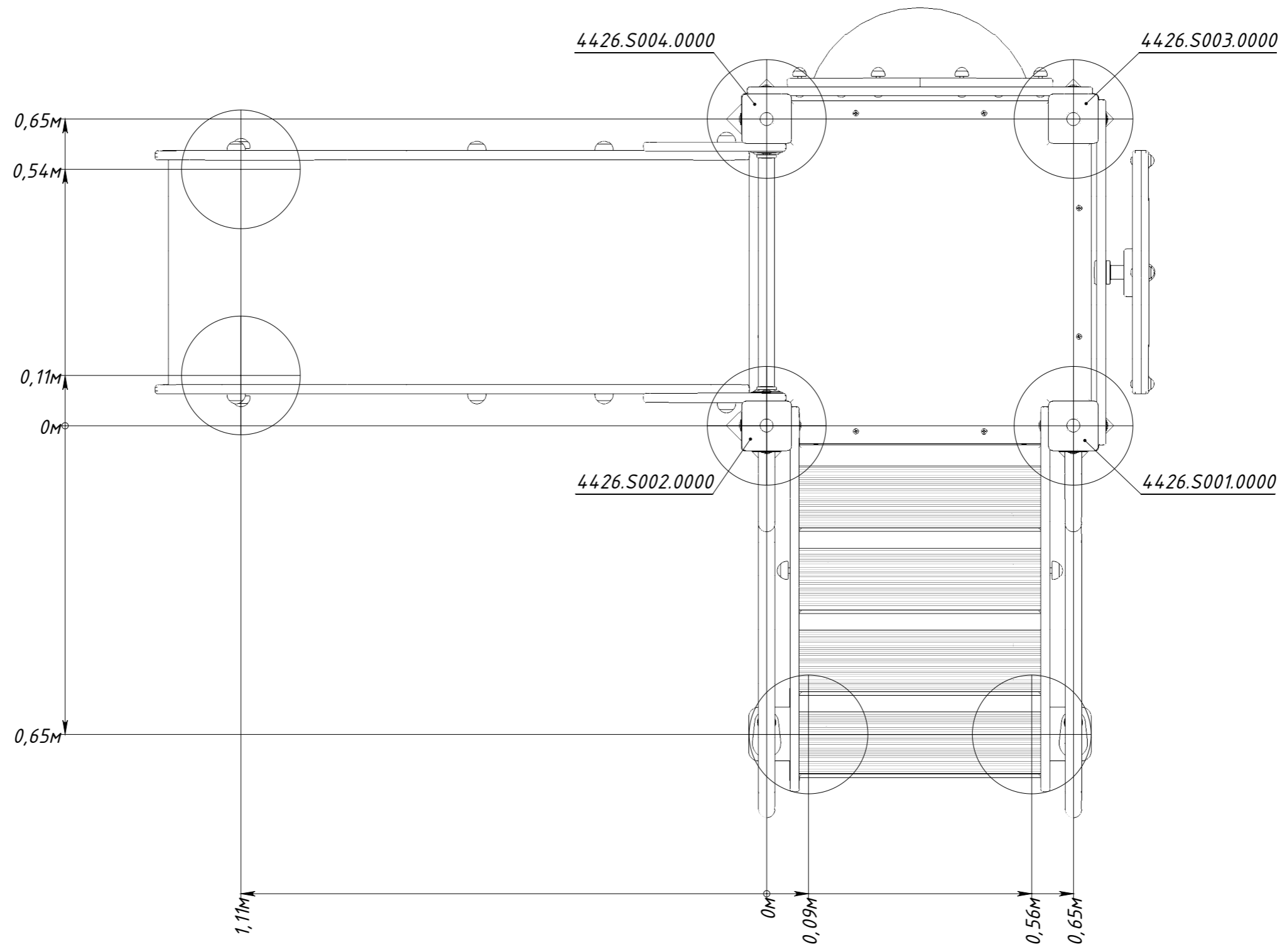

Рисунок 1