

Схема скважин  
4207.0000.0000

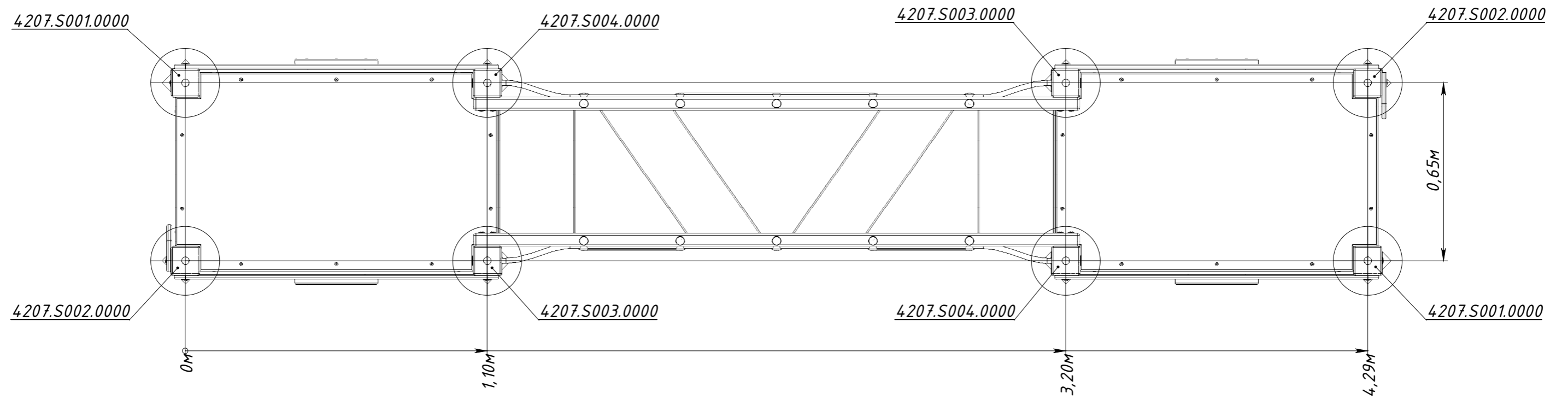

Рисунок 1